



www.jwell.cn  
www.jwellhn.cn



地址: 浙江省嘉兴市海宁斜桥工业园区庆丰路128号  
Tel:+86-573-87786088 (86)13501675166  
Add:No.128, Qingfeng Road, Xieqiao Industrial Zone, Haining City, Zhejiang  
Tel: 86-573-87786088 (86)13501675166  
E-mail: sales@jwell.cn

邮编:314406  
传真: 86-573-87787788  
Postal code:314406  
Fax: 86-573-87787788  
Complaint E-mail: info@jwell.cn

版本号Edition No.: 2022.07



# 绿色生态 Green Ecological Decovation 装饰材料设备系列 Materials Equipment Series



**金纬机械(海宁)有限公司**  
**JWELL MACHINERY (HAINING) CO., LTD.**



A Global Supplier of Complete Solutions on Extrusion Technology  
 金纬机械—全球挤出技术 整体解决方案供应商

10+ 驻海外办事处 Overseas offices  
 580+ 技术研发&工程师 R&D Engineer  
 3,000+ 金纬机械员工人数 Jwell Employee  
 8+ 个制造基地 Manufacture Bases  
 500+ 独家专利技术 Patents  
 1,000,000m<sup>2</sup>+ 工厂面积 Plant Area



80年代初

金海螺第一代螺杆研制成功  
 In the early 1980s, the first generation screw of JINHAILUO was successfully developed

1997

上海金纬机械  
 Shanghai JWELL Machinery

2008

苏州金纬机械  
 Suzhou JWELL Machinery

2012

常州金纬机械  
 Changzhou JWELL Machinery

2018

贝克威尔 (泰国)  
 Bkwell (Thailand)

2019

浙江金纬智能装备  
 Zhejiang JWELL Machinery

2020

金纬公司业绩突破50亿人民币  
 Jwell's annual sales exceeded CNY 5 billion

2021

滁州金纬机械  
 Chuzhou JWELL Machinery

2022

连续11年荣获中国塑料机械挤出行业排名首位  
 Ranked first in China's plastic machinery extrusion industry for 11 consecutive years

We Know Extrusion

# HAINING JWELL MACHINERY

金纬机械(海宁)有限公司是金纬机械旗下的又一个重要发展战略中心和制造基地，位于浙江省海宁市斜桥工业园区。一期用地115亩，厂区内配套有先进的零部件CNC机械加工基地和规范的装配车间，年产800套塑料挤出智能装备。公司专注于塑料挤出装备制造和全方位的专业技术服务，用心制造符合全球中高端用户所需的塑料挤出设备。严谨的设计、严格的标准化制造过程、完善的售后服务保障体系，为用户提供高效、节能、品质卓越的生产线设备和贴心的服务。



公司产品已遍布全国各地，并出口到俄罗斯、印度、韩国、印尼、中东、非洲和南美洲、西班牙、意大利等100多个国家和地区，深受客户好评。

### “品质卓越 完美如一”

是金纬公司的质量方针，是全体员工努力的方向。

### “诚实待人”

是我们铸就“百年金纬”的核心理念。

董事长：何海潮 Email: he@jwell.cn



Jwell Machinery (Haining) Co.,Ltd is one more important strategic center and production base of JWELL Group. It is located in XIEQIAO Industrial zone of Haining city, Zhejiang Province. The 1st company infrastructure is designed for 76,500 square meters factories, this new factories are equipped with a lot advanced CNC machining centers and well-organized assembling workshops. Every year, there will be more than 800 intelligent extrusion equipments manufactured from this production base. Jwell Machinery (Haining) Co.,Ltd is focus on manufacturing plastic extrusion equipments, complete and professional technical service, we are dedicated to offering Customized extrusion equipments for our global customers. Rigorous technical design, Strict and standard production process, complete after-sale service and maintenance system, ZHEJIANG JWELL is providing high-efficiency, energy-saving, outstanding-quality extrusion equipments and caring service to our customers.

JWELL and Jinhailuo 金海螺 are famous brands in Chinese plastic machinery industry.

JWELL machinery has been sold across the country, and exported to all continents over the world, including the market of developed country, such as Germany, America, Japan, Spain and so on.

"Excellent Quality, Perfect All" is Jwell's quality policy, and all staff's working direction.

"Be honest" is the core idea for us to contribute "Century JWELL"

President: He Haichao Mobile/WhatsApp +86 13601628188





## PVC异型材高速生产线 PVC High Speed Profile Extrusion Line

**应用:** YF塑窗异型材生产线用锥双或平双螺杆挤出机,可加工PVC塑料门窗异型材、钢塑复合异型材、装饰型材等。

**性能和优点:** 参照国外最新技术,对机组进行优化设计,具有塑化均匀,剪切速率小,产量高,使用寿命长等优点。该机组有双螺杆挤出机、真空定型台、牵引机、切割机、贴膜机、翻料架等组成。主机采用进口交流变频或直流调速拖动,温控仪表采用进口品牌。辅机真空泵和牵引电机均采用优质产品,维护简便,更换螺杆机筒及模具后,可以直接挤出仿真木发泡异型材,效果比单螺杆更佳。

**Application:** YF series production line is designed for conical or parallel extrusion of PVC plastic window and door's ,steel-plastic composit and decoration profile.

**Properties and advantages:** This line features stable Plasticization, high output,low sheering force,long life service and other advantages. The production line consists of control system, conical twin screw extruder or parallel twin screw extruder,extrusion die, calibration unit,haul off unit, film covering machine and stacker. The extruder is equipped with alternating-current inverter (ABB or Eurotherm drive), imported temperature controller (RKC,Japan). The calibration unit's pump and haul off unit's reducer are famous brand products. After simple changing of the die and screw, it also can produce the foam profiles.

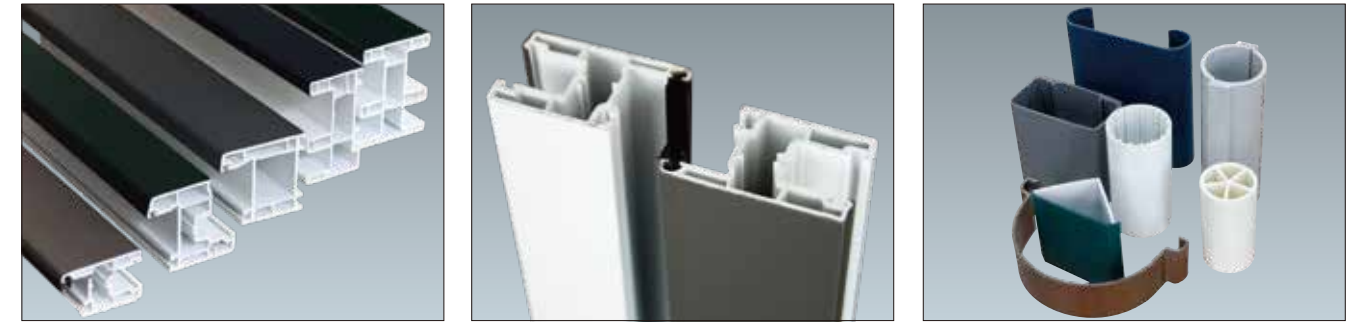

### 主要技术参数 Main technical parameter

型号 Model	YF240	YF240	YF240A
最大制品宽度 Max.width of product (mm)	240	240	150*2
主机型号 Extruder model	SJP75/28	SJP93/28/31	SJP110/28
最大挤出量 Max.extrusion capacity (kg/h)	150-250	250-400	400-500
主机功率 Extruder power (kw)	37	55	75
冷却水用量 Cooling water (m³/h)	7	8	10
压缩空气用量 Compressed air (m³/min)	0.6	0.6	0.8

备注: 以上规格参数如有变更,恕不另行通知。Note:The specifications are subject to change without prior notice.

## PVC木塑快装墙板生产线 PVC Wood-Plastic Quick Assembling Board Extrusion Line

该生产线主要用于生产木塑装饰材料，制品广泛用于家装和工装市场，具有无污染、高寿命、抗冲击、保温隔热、防水防潮、防火阻燃、易安装易擦洗、高效省时、时尚美观、可回收利用等特点，可用于高档墙饰面、吊顶、门套、窗套、吸音、保温要求的场所。

The machine is used for producing WPC decoration product, which is widely used in house and public decoration field, features non-pollution, high lifetime, heat insulation, anti-fire, easy clean and maintenance, easy change and recyclable. It can be of high quality decoration material, ceiling, door frame, window frame, sound proof and heat insulation.

### 主要技术参数 Main technical parameter

制品最大宽度 Production width (mm)	180	300/400	600
主机型号 Extruder type	SJZ51/105	SJZ65/132	SJZ80/156
主机马达 Motor power (kw)	22	37	55
辅机型号 Type	YF180	YF300/400	YF600
最大挤出量 Output (kg/h)	80-100	150-200	300-400
冷却水用量 Cooling water (m <sup>3</sup> /h)	6	7	8
压缩空气用量 Compressor air (m <sup>3</sup> /min)	0.6	0.6	0.6

备注：以上规格参数如有变更，恕不另行通知。Note: The specifications are subject to change without prior notice.

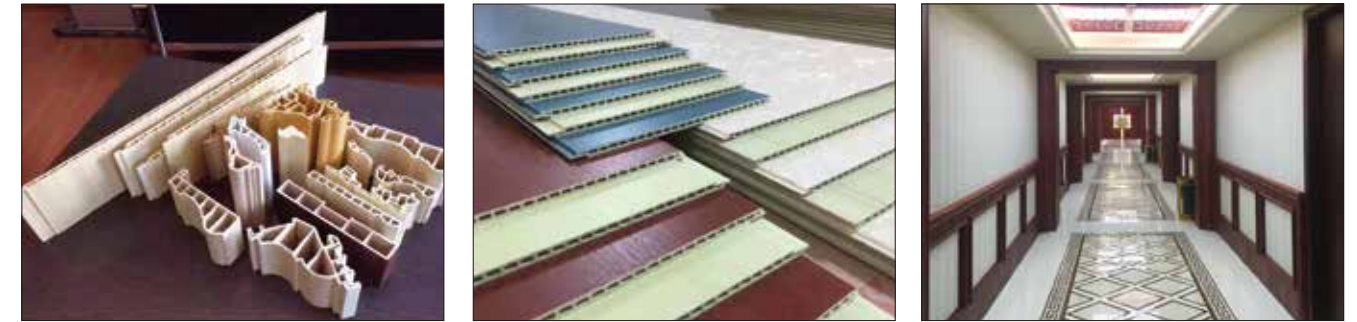



## PVC单螺杆木塑(发泡)挤出生产线 PVC Single-screw WPC (foaming) Extrusion Line

该生产线主要用于生产长城板、内墙板、隔断墙、天花扣板、吸音板、楼梯扶手、百叶窗、地脚线等装饰型生态木产品，挤出机部件采用专用的螺杆设计，避免原材料的高剪切和过塑化，生产出的产品表面木纹纹理仿真明显，产品不变形、不褪色、防火、防腐、防虫蛀，耐老化和抗紫外线。

The production line is mainly used for the production of the Great Wall panels, inner wall panels, partition walls, pinch plate, acoustic panels, stair handrail, window-shades, foot line and some decorative ecological wood products. The extruder with the unique screw design prevents raw material from high shear or over plasticizing. As a result, products gain significant texture of wood surface, and product with characteristics: no deformation, non-fading, fire prevention, anti-corrosion, anti-moth, anti-aging and anti-UV.

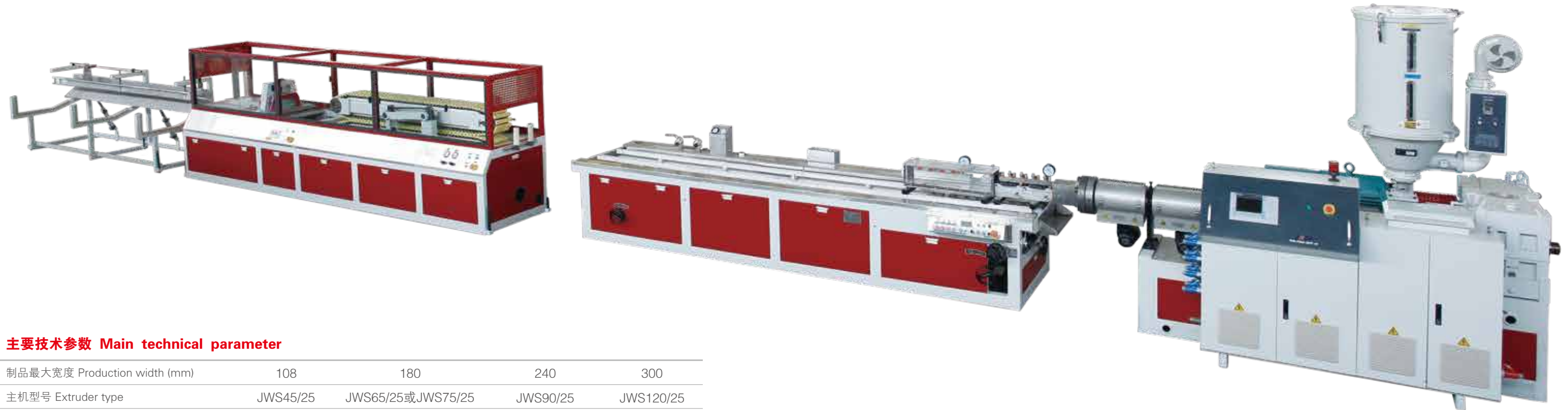
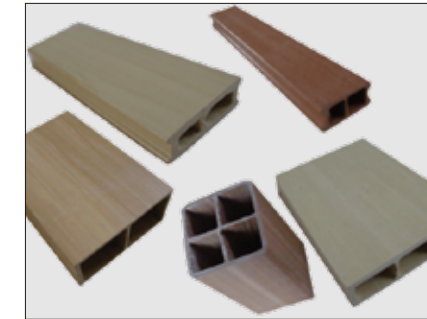
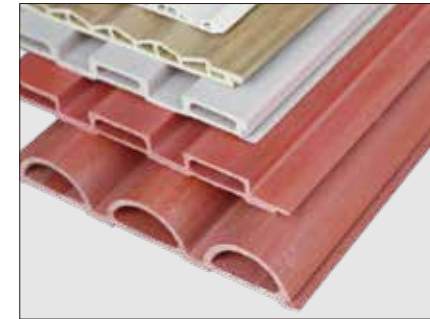

### 主要技术参数 Main technical parameter

制品最大宽度 Production width (mm)	108	180	240	300
主机型号 Extruder type	JWS45/25	JWS65/25或JWS75/25	JWS90/25	JWS120/25
主机马达motor power (kw)	11	22/30	37/45	55
辅机型号 Type	YF108	YF180	YF240	YF300
最大挤出量 Output (kg/h)	20	50/70	90	150
冷却水用量 Cooling water (m <sup>3</sup> /h)	7	7/7	8	9
压缩空气用量 Compressor air (m <sup>3</sup> /min)	0.5	0.6/0.6	0.8	0.8

备注: 以上规格参数如有变更, 恕不另行通知。Note: The specifications are subject to change without prior notice.

## PVC硬质/PVC木塑宽幅板材生产线 Rigid PVC/WPC Door Board Extrusion Line

### 性能特点:

该机组采用专门设计的SJZ92锥形双螺杆挤出机，采用直流调速拖动，进口品牌温控仪表，具有调速范围广，温控精度高，操作方便可靠等优点。辅机由真空定型台、牵引机、切割机及堆料架组成。配备大型强制冷却装置确保板材定型效果。履带式牵引机采用精密减速电机及变频器，具有结构合理、牵引力大，牵引稳定等优点。切割机具有工作可靠准确，切割精度高的优点，堆料架附有可移动的推料小车和特制的橡胶保护层，具有不伤料，使用简便等优点。辅机机组采用可编程电脑控制或国产名牌控制系统，整机控制可靠稳定。

### Performanc and advantages:

The extruder of this extrusion line is the special designed SJZ92 conical twin-screw extruder, this extruder is equipped with the temperature controlling gauges which have the advantages of high precision temperature controlling, easy and reliable operation. The vacuum calibration table equipped with the strong cooling device which ensures the cooling effect. Caterpillar type haul off unit, equipped with the precise speed reduction motor and inverter, has the advantages of reasonable structure, powerful and stable haul off force. The cutter has the reliable and accurate cutting effect. The stacker has the movable stacking trolley and special made rubber protection layer to prevent the product from being scratched. The downstream equipment of this extrusion line uses the programmable computer or domestic made controlling system for stable and reliable operation.



### 主要技术参数 Main technical parameter

型号 Type	YF800	YF1000	YF1250
最大制品宽度 Max. width of product (mm)	800	1000	1250
主机型号 Extruder type	SJZ 80/156	SJZ 92/188	SJZ 92/188
最大挤出量 Max. extrusion capacity (kg/h)	320	450	500
主机功率 Extruder power (kw)	55	110	132
冷却水用量 Cooling water (m <sup>3</sup> /h)	13	15	18
压缩空气用量 Compressed air (m <sup>3</sup> /min)	0.6	0.8	1

备注: 以上规格参数如有变更, 恕不另行通知。Note: The specifications are subject to change without prior notice.



## PE&PP木塑地板挤出生产线 PE&PP Wood-Plastic Floor Extrusion Line

PE&PP木塑地板是指木塑复合材料的配混、脱挥、制品挤出成型分别在不同的设备中完成，即原材料按一定配方配混好之后，中间造成木塑颗粒，再挤出加工成木塑地板的这个过程。

目前两步法应用较为广泛，一般是用锥双挤出机或平双挤出机造粒，再用锥双或单螺杆挤出机挤出成型制品，主要使用在室内外地板、护栏、托盘等PE&PP类木塑产品的挤出成型。

PE&PP Wood-Plastic Floor is that the wood-plastic composite materials complete in different equipments of mixing, from play, extruding products, mixing the raw material in a certain formula, forming wood-plastic particles in the middle, and then squeezing out products.

And nowadays, the two-step way is used currently, application of a wider general use dual-cone-or two-extruder extruder granulation, and then double-cone or single screw extruder extrusion products, mainly used in floor indoor or outdoor, para-pets, tray, such as PE&PP plastic extrusion products.



### 主要技术参数 Main technical parameter

主机型号 Model	螺杆规格 mm	主电机功率 Power of main motor(KW)	生产能力 Output(kg/h)
SJZ65	65/132	37	150-180
SJZ72	72/152	45	220-300

备注：以上规格参数如有变更，恕不另行通知。Note:The specifications are subject to change without prior notice.

## PS 塑料发泡镜框型材生产线 PS Foamed Picture Frame Extrusion Line

YF系列PS塑料发泡镜框型材挤出生产线，主要有单螺杆主挤出机和配套共挤机，冷却水槽，热转印机组，牵引机，切割机，翻料架组成，整条生产线配有进口ABB交流变频器控制，进口RKC温空仪表等元部件，具有塑化好，产量高，使用可靠的特点。其中热转印机组是根据进口样机改进设计而成，它主要采用热压印的方式，将色带上的涂料压印在发泡PS异型材上。该机外观美观、性能可靠、使用方便、烫印精确、吸附力强。且调节手轮可以压印各种不同形状的异型材。该设备主要和塑料挤出机、牵引机、切割机等配套使用，是目前塑料机械行业新开发的一种最新的配套辅机。

YF Series PS Foam Profile Extrusion Line, consists of single screw extruder and the special co-extruder, with the cooling water tank, hot stamping machine system, haul-off unit, and stacker. This line with imported ABB AC inverter control, imported RKC temperature meter etc. and features of good plasticization, high output capacity, and stable performance etc. The hot stamping machine system combined foreign technology, by the hot stamping embossing method, transfer the coating layer from the film to the PS foamed profile. The machine with good appearance, stable performance, accurate & easy operation. By adjust the embossing wheel the machine can work on various of different profiles. Working together with the main extruder and other extrusion down steam equipments, this line is popular as the latest developed producing line.



### 主要技术参数 Main technical parameters

型号 Model	YF1	YF2	YF3	YF4
主机 Extruder	JWS65	JWS90	JWS100	JWS120
共挤机 Co-extruder	JWS35	JWS45	JWS45	JWS45
生产制品宽度 Products width	3inch	4inch	5inch	6-8inch
配套热转印机 Hot stamping machine	8组	10组	10组	12组
生产线速度 Speed	2-6m/min	2-6m/min	2-6m/min	2-6m/min

备注：以上规格参数如有变更，恕不另行通知。Note: The specifications are subject to change without prior notice.



## PVC/PP/PE/PC/ABS等异型材挤出生产线 PVC、PP、PE、PC、ABS Small Profile Extrusion Line

本公司吸取了国内外先进技术，成功开发出适合用户需求的小型材生产线。该机组有单螺杆挤出机或双螺杆挤出机、真空定型台、牵引机、切割机、翻料架等几部分组成，生产线具有塑化好，产量高，能耗低等显著特点。主机采用进口交流变频器调速，温控仪表采用日本RKC产品。辅机真空泵和牵引电机均采用优质产品，维护简便。

By adopting the foreign and domestic advanced technology, we successfully developed the small profile extrusion line. This line consists of Single Screw Extruder, Vacuum Calibration Table, Haul-off Unit, Cutter and Stacker, the producing line features of good plasticization, high output capacity, low power consumption and etc. The main extruder speed controlled by imported AC inverter, and temperature control by Japanese RKC temperature meter, vacuum pump and traction gear reducer of the down stream equipment are all good quality products, and also easy maintenance.

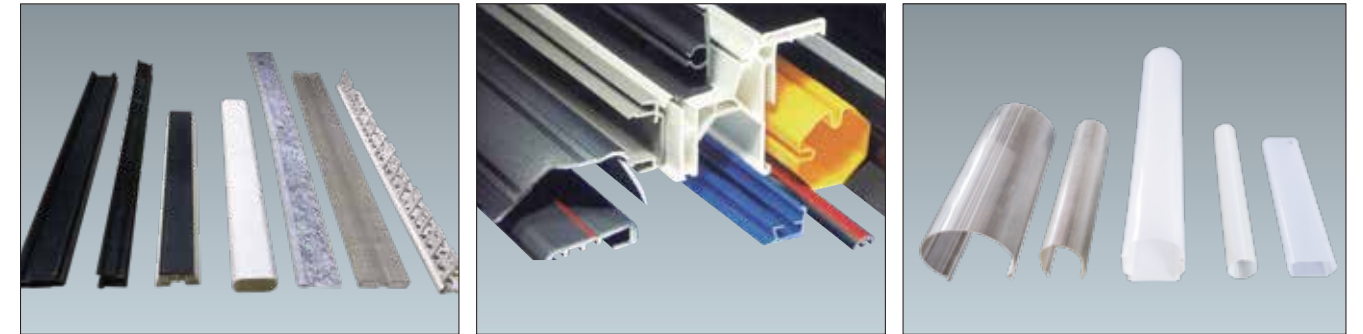

### 主要技术参数 Main technical parameter

型号 Model	YF50	YF108	YF180	YF240	YF300
最大制品宽度 Max. width of product (mm)	50	108	180	240	300
主机型号 Extruder model	JWS 45	JWS 50	JWS 65	JWS 90	JWS 120
驱动功率 Power (kw)	15/11	22/18.5	30/22	55/45	90/75
冷却水用量 Cooling water (m <sup>3</sup> /h)	4	4	5	7	7
压缩空气用量 Compressed air (m <sup>3</sup> /min)	0.5	0.6	0.6	0.6	0.6

备注：以上规格参数如有变更，恕不另行通知。Note:The specifications are subject to change without prior notice.

## PVC/TPU/TPE密封条生产线

### PVC、TPU、TPE Seal Profile Extrusion Line

该生产线主要用于加工PVC、TPU、TPE等不同材料的密封条，性能稳定产量高、能耗低等特点。主机采用进口交流变频调速，西门子显示屏，操作简单，维护方便。

The machine is used for producing seal of PVC, TPU, TPE etc material, features high output, steady extrusion, low power consumption. Adapting famous inverter, SIEMENS PLC and screen, easy operation and maintenance.



#### 主要技术参数 Main technical parameter

主机型号 Extruder type	JWS45/25	JWS65/25
主机马达 Motor power (kw)	7.5	18.5
最大挤出量 Output (kg/h)	15-25	40-60
冷却水用量 Cooling water (m³/h)	3	4
压缩空气用量 Compressor air (m³/min)	0.6	0.6

备注：以上规格参数如有变更，恕不另行通知。Note: The specifications are subject to change without prior notice.



## 5G天线罩挤出生产线 5G Radome Extrusion Line

随着5G时代到来，推动对基站起防护作用的天线罩从材料到相关设备的快速发展，传统的玻璃钢天线罩以不能达到相关要求，PVC天线罩已经有了一定应用，但随着新型材料的试验，应用，如PC+玻纤,PP+玻纤，ASA等，其主要优点有：低介电、低损耗、轻量化、环保。

根据市场需求，我公司相应研发推出：PVC、PC+玻纤、PP+玻纤、ASA天线罩挤出生产线。

With the advent of 5G era, the fast development of radome for base-station protection is promoted with material and related equipment. The traditional FRP radome can not satisfied with the relevant requirements. PVC radome has some application to certain extent. However, with some testing and application of new materials, such as PC + glass fiber, PP + glass fiber, ASA etc, the main advantages are: low dielectric, low cost, light-weight, environmental.

According to the market demand, Jwell has researched, developed and launched: PVC, PC + glass fiber, PP + glass fiber, ASA radome extrusion machine line.



### 主要技术参数 Main technical parameter

机型 Model	SJZ65	SJZ80	JWS90	JWS100
螺杆规格 Screw size	65/132	80/156	90/33	100/33
主电机功率 Motor power	37KW	55KW	75KW	110KW
产能 Output	150-200KG/H	250-350KG/H	120-150KG/H	150-200KG/H

## PVC线槽挤出生产线 PVC Plastic Trunk Extrusion Line

PVC线槽只是线槽的一种，主要是用于电气设备内部布线，现在普遍使用的有环保阻燃PVC线槽。

- 1、PVC线槽具有绝缘、防弧、阻燃自熄等特点。
- 2、PVC线槽主要起到机械防护和电气保护的作用。
- 3、PVC线槽配线方便、布线整齐、安装可靠，还便于查找、维修和调换线路。

PVC trunk is a kind of trunks, which is mainly used for internal wiring routing of electrical equipment. Now, environmentally friendly & flame retardant PVC trunk is widely used.

1. PVC trunk has the characteristics of insulation, arc protection, flame retardant and self extinguishing etc characteristics.
2. PVC trunk mainly plays important role of mechanical protection and electrical protection.
3. PVC trunk is convenient for wiring, neat wiring routing, reliable installation, and also easy to find, repair and replace wire routing line.

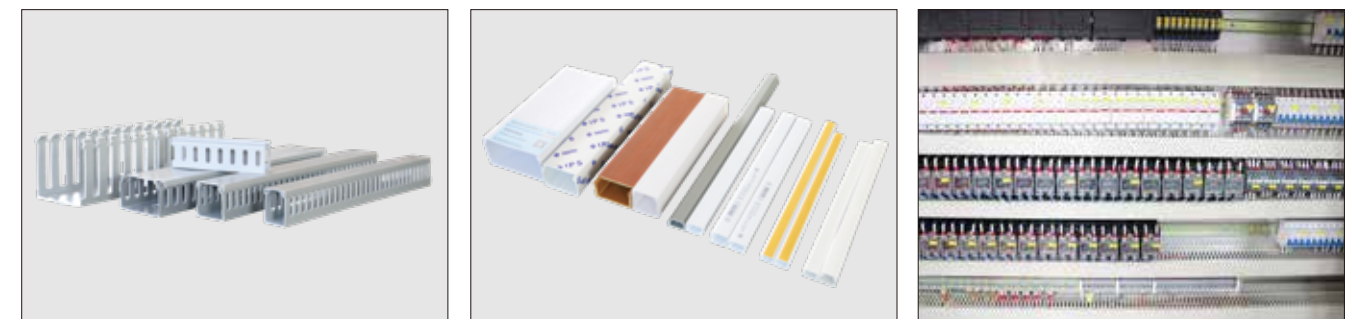

### 主要技术参数 Main technical parameter

机型 Model	SJZ51	SJZ55	SJZ65
螺杆规格 Screw size	51/105	55/110	65/132
主电机功率 Motor power	18.5KW	22KW	37KW
产能 Output	80-100KG/H	100-150KG/H	150-200KG/H

## 高分子塑钢桥架挤出生产线 High Molecular Weight(HMW) Plastic Reinforced Steel Bridge Extrusion Line

高分子塑钢桥架主要分为复合型塑钢桥架和衬钢型塑钢桥架两种类型，是一种新型材料的桥架产品，该产品目前已经在化工、石油、电力、医药、建筑等行业和沿海地区广泛使用。它可取代目前传统的电缆桥架，在欧美发达国家已得到广泛应用，是未来工程应用首选的电缆桥架，符合国家“以塑代钢”的政策，并具有阻燃、耐腐、机械强度优、绝缘性能好、结构合理、外形美观和使用寿命长等特点。它综合了钢制桥架、玻璃钢桥架和铝合金桥架在不同工况和气候条件下的使用情况后研发而成。

HMW Plastic Reinforced Steel Bridge mainly divide into composite plastic bridge and plastic reinforced steel bridge. It is a kind of new and advanced bridge material series product. It already has been widely used in chemical industry, petroleum, electric power, medicine, construction and other industries and coastal areas. It can replace current traditional cable tray, and has been widely used in developed countries in EU and USA. It is the preferred cable tray for future engineering application. It conforms to the national policy of "replacing steel with plastic", and has the characteristics: flame retardant, corrosion resistance, excellent mechanical strength, good insulation performance, suitable structure, beautiful appearance and long service life. It integrates steel bridge, glass fiber reinforced plastic bridge and aluminum alloy bridge in different conditions and climatic conditions, then researched and developed.



### 主要技术参数 Main technical parameter

机型 Model	SJZ65&JWS45	SJZ80&JWS50	SJZ92&JWS50
螺杆规格 Screw size	65/132	80/156	92/188
主电机功率 Motor power	37KW	55KW	110KW
产能 Output	150-200KG/H	250-350KG/H	500-600KG/H

## 环保高分子塑钢板桩主要应用领域 Main Application Fields Of Environmental&High Molecular Weight(HMW) Plastic Reinforced Steel Profile

塑钢板桩是由环保高分子复合材料与多种添加剂混合后，通过塑化挤出，模具定型，冷却，切割成型的一种高强度新型产品。产品外形设计依据力学原理，采用大惯性矩截面设计，搭配多向凹凸接头，组合成为连续性高强度、耐酸碱、抗老化、高抗侧弯性能的新型生态护岸结构体系，且施工效率高，其应用领域市场广阔。

河涌及湿地环境项目：水土生态改造、人工湖岸、河堤护岸项目建设。  
 防灾减灾工程：防洪涝、防塌方、防渗漏、防泥石流、防风沙等。  
 农田水利项目：水产养殖业、灌溉渠道、中小型水库堤坝建造及维护。  
 市政交通工程：路基防护、隧道、涵洞、管道铺设、道路修建、港口码头、船坞建造。  
 海洋开发项目：海防堤坝围筑、防波墙、盐碱地、海产养殖基地的基围建设等领域。  
 建筑工程：基坑支护、护坡、挡土、围墙、花池、防渗墙、止水围堰、地基处理、地下停车场、污水处理等。

HMW Plastic Reinforced Steel Profile is a new type of high strength product, which is made of environmental polymer composite with a variety of additives, process by plasticizing extrusion, mold calibration, cooling and cutting. The product design is according to the principle of mechanics, and adopts the design of large inertia moment section, and collocation with multi-direction sharp joint. It is a new type of ecological revetment structure system with continuous high strength, acid and alkali resistance, anti-aging and high lateral bending resistance. It has high construction efficiency and wide application.

River and wetland environment project: water and soil ecological transformation, artificial lake bank, river bank protection project construction.  
 Disaster prevention and mitigation projects: flood control, collapse prevention, seepage prevention, debris flow prevention, wind sand prevention, etc.  
 Irrigation and water conservancy projects: aquaculture, irrigation channels, dam construction and maintenance of small and medium-sized reservoirs.  
 Municipal Traffic Engineering: sub-grade protection, tunnel, culvert, pipeline laying, road construction, port and dock construction.  
 Marine development projects: Construction of coastal dike, wave wall, saline alkali land, foundation construction of mariculture base, etc.  
 Construction Engineering: foundation pit support, slope protection, soil retaining, wall, flower pool, anti-seepage wall, water stop cofferdam, foundation treatment, underground parking lot, sewage treatment, etc.



### 主要技术参数 Main technical parameter

机型 Model	SJZ80	SJZ92
螺杆规格 Screw size	80/156	92/188
主电机功率 Motor power	55KW	110KW
产能 Output	300-400KG/H	500-700KG/H



## SPC石塑环保地板生产线 SPC Stone-plastic Environmental Floor Extrusion Line

SPC地板主要由PVC、钙粉组成，经过塑化挤出片材，零甲醛的环保地板。复合结构：第一层，表面UV耐磨层，固化表面光泽度；第二层，0.3-0.7mmPVC耐磨层，提高耐磨性；第三层，印刷花色层，各种定制化花纹，满足用户的个性化定制；第四层，PVC基材层，主要由PVC和钙粉通过挤出生产线挤出成型，与耐磨层、印刷层热复合成型，不用胶水；第五层，静音贴，XPE发泡层，提高地板踩踏舒适度。

The SPC floor which is composed of PVC raw material and calcium powder is a kind of the non-formaldehyde environmentally friendly floor processed by plasticizing and extruding the sheet. Composite structure: The first layer: the surface is UV wear resistance layer, enhancing surface gloss; The second layer: 0.3-0.7mm PVC wear resistance layer, improving its wear resistance character; The third layer: printing color layer, through various customized patterns to meet the user's personalized customization; The fourth layer: the PVC base material layer, made of PVC and calcium powder mainly formed by the extruder, and then thermal composited with the wear resistance layer and the printing layer without glue; The fifth layer: mute paste, XPE foam layer, improving the comfort feeling of the floor.

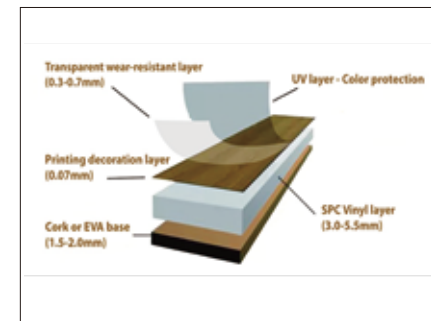
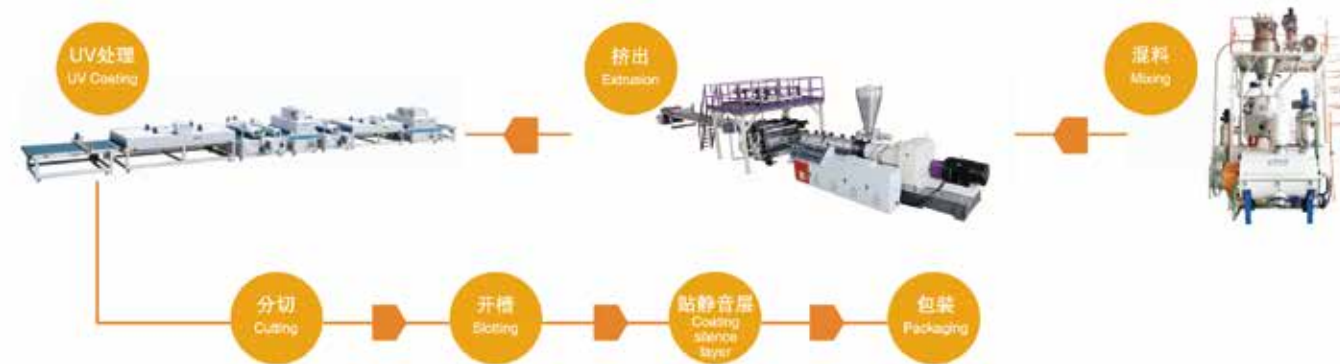

## 门、窗、隔断墙加工运用 Door, Window, Partition Wall Application

PVC木塑门、PVC窗型材、PVC隔断墙体特点：色彩丰富彩色塑钢型材的适用给建筑增添的不少姿色。以前使用木制门窗，为了达到门窗与建筑外观和谐一致，多在门窗表面喷涂油漆，油漆遇紫外线容易老化剥落，用不了几年就面目全非，与建筑物的寿命很不协调。塑料门窗的使用解决了这个问题，彩色贴膜型材甚至可以做出以假乱真的木纹效果。经久耐用：抗紫外线成分的加入也使塑钢型材的耐候性得到提高，即使紫外线很强的热带地区也能放心使用。保温性能好：塑钢型材本身导热性能远不及铝型材，另外多腔结构的设计更是达到了隔热的效果。隔音性能好：安装中空玻璃密封良好的塑钢门窗具有优良的隔音性能。隔音已经成为选择门窗的主要条件，特别是在闹市区的住宅。

Features of PVC wood plastic door, PVC window profile, PVC wall: Rich colors: The application of colored steel profiles adds a lot of colors to the building. In the past, wooden doors and windows were used. In order to achieve the harmony of the doors, windows and the appearance of the construction, most of the paint was sprayed on the surface of them. The paint was exposed to ultraviolet rays and easily aging and peeling off. It took a few years to be completely unrecognizable. The using of plastic doors and windows solves this problem. The colored film profiles can even make a vivid wood texture effect. Durable: The addition of UV-resistant ingredients also improves the weather ability of steel profiles, even in tropical areas where UV light is strong. Good heat preservation performance: The thermal conductivity of the steel profile itself is far less than that of the aluminum profile, and the design of the multi-cavity structure achieves the effect of heat insulation. Sound insulation performance: The installation of good personality plastic steel doors and windows can enhance sound insulation performance. Sound insulation has become the main reason for selecting doors and windows, especially in downtown areas.





## 城市固废处理专用撕碎机 Shredder For Urban Solid Waste

为了环保并适合不同的产量要求和破碎对象，DYUN推出DYSSQ轻型撕碎机。适用于注塑、吹塑、挤出过程中产生的浇口、塑料厚板、建筑模板、塑料薄膜及各类中空容器的撕碎回收。根据现场不同的喂料方式及再利用，可配输送机及破碎机。低速的转刀，低噪音、高产量、更节能。

DYUN invents the DYSSQ type light shredder in order to be suitable for different capacity requirements and products. This shredder can be used for gates, plastic thick plates, building templates, plastic films and various hollow containers. It can be equipped with conveyors and crushers according to different feeding methods. It will be more energy saving with low speed rotary cutter. The shredder has advantages of low noise and high output.



## 固废高分子材料回收处理应用工艺 Solid Waste Polymer Material Recycling Processing

### 废塑料托盘工艺 Plastic Waste Pallet Processing

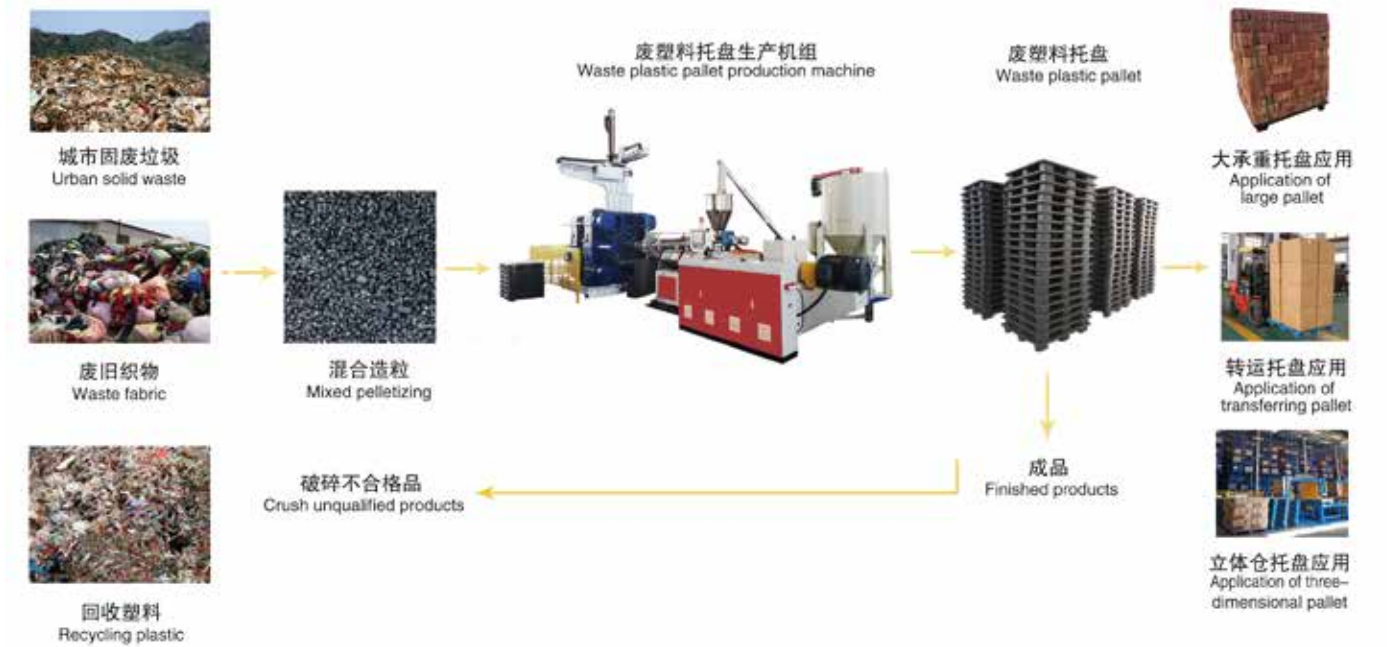

### 纤塑复合地板工艺 Fibre & Plastic Composite Floor Processing

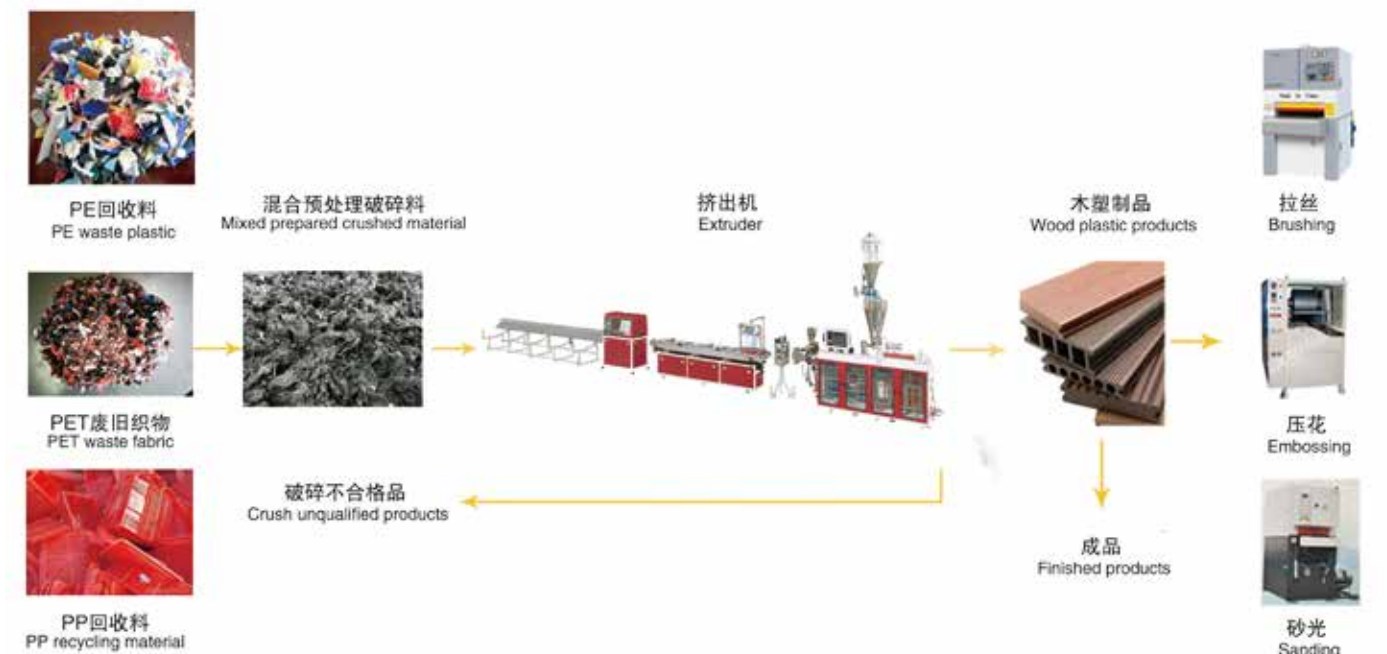



## PVC中空板材 PVC hollow plate

PVC中空板材，采用树脂生产而成，适用于产床、保育床的围栏板，有效避免仔猪之间疫情传染，易于清洗适用于仔猪保温箱，有效提高保温效果。

PVC hollow plate is composed of pvc resin. It is suitable for guardrail board which is easy to clear and effectively avoids epidemic infection among pigs. Besides, it has good features of heat preservation which can be used for piglets incubators.

1、以聚氯乙烯（PVC）树脂+碳酸钙（CaCO<sub>3</sub>）为基材，产品环保无污染，可回收再利用。

Based on polyvinyl chloride (PVC) resin+calcium carbonate (CaCO<sub>3</sub>), the product is environmentally friendly and nonpolluting, and can be recycled and reused.

2、表面平整光洁，耐酸碱、耐腐蚀、不吸潮、不霉变、易清洁、防病菌，提高家禽养殖的健康；

The surface is smooth and smooth, acid and alkali resistance, corrosion resistance, no moisture absorption, no mildew, easy to clean, anti-bacteria, improve the health of poultry farming.

3、有助于保持家禽活动区的清洁和对家禽的集体管理，大大提高养殖质量，给动物一个五星级的家。

It helps to keep the poultry activity area clean and realize collective management of poultry. It greatly improves the quality of breeding and give animals a healthy and happy life.



### 主要技术参数 Main technical parameters

型号 Model	YF600	YF1000	YF1000
最大制品宽度 Max. width of product(mm)	600	1000	1000
主机型号 Extruder type	SJZ 80/156	SJZ 80/156	SJZ 92/188
最大挤出量 Max.extrusion capacity(kg/h)	350	450	500
主机功率 Extruder power(kw)	55	55	110
冷却水用量 Cooling water(m <sup>3</sup> /h)	13	15	15
压缩空气用量 Compressde air(m <sup>3</sup> /min)	0.6	0.8	0.8

备注：以上规格参数如有变更，恕不另行通知。Note:The specifications are subject to change without prior notice.

## PVC连接件系列 PVC Connection Unit

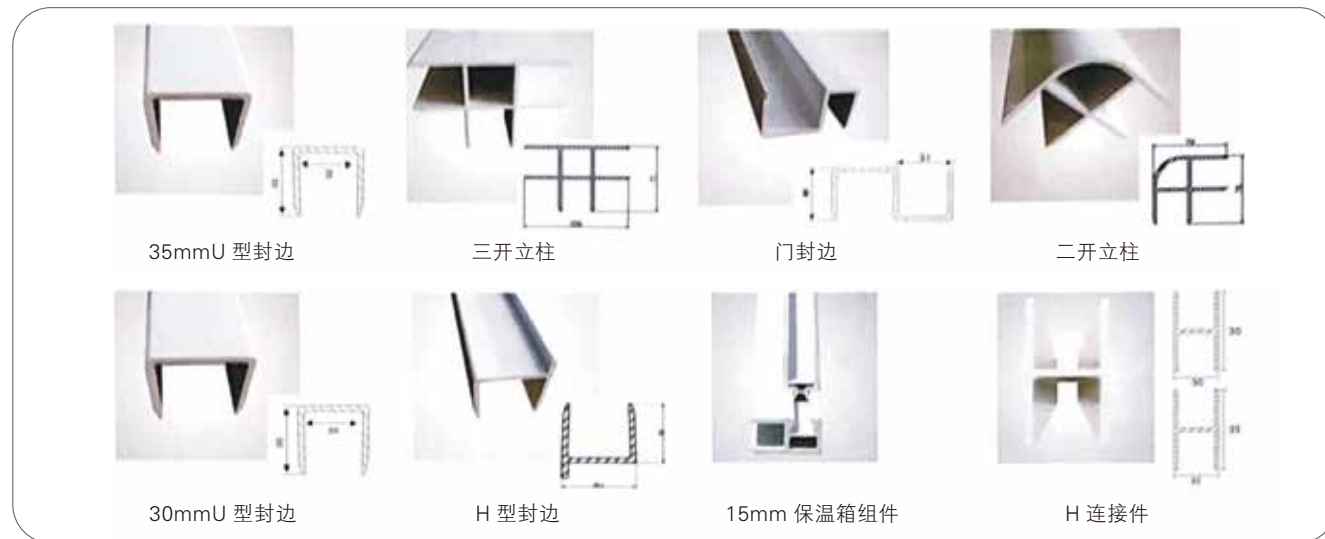

PVC围栏在构件的连接上，与其它普通护栏完全不同，是真正意义上的永不锈蚀围挡，并具有不导电与防爆性能。采用完全创新的榫连接方式，使竖杆与横杆，横杆与立柱的连接彻底解决了普通围挡在螺丝联接部位仍会迅速锈蚀的重大缺点。

The connection of PVC fences is completely different from other ordinary fences. It completely solves problems of rusting and instability because of adopting innovative connection type. This PVC fence has good features of non-corrosive, nonconductive and explosion-proof.



### 主要技术参数 Main technical parameters

型号 Model	YF240	YF240
最大制品宽度 Max. width of product(mm)	240	240
主机型号 Extruder type	SJZ 50/105	SJZ 65/132
最大挤出量 Max.extrusion capacity(kg/h)	110	220
主机功率 Extruder power(kw)	18.5	37
冷却水用量 Cooling water(m³/h)	7	8
压缩空气用量 Compressed air(m³/min)	0.6	0.6

备注：以上规格参数如有变更，恕不另行通知。Note:The specifications are subject to change without prior notice.

## PVC排污槽 PVC Sewage tank



用途：猪场鸡场自动刮粪机专用。  
Application: pig farm, chicken farm, automatic manure scraper.

PVC排污管是排污系统中必不可少的一个环节，该产品强度高、不吸水、不渗水、不变性、不变形、性能稳定，连接可用水泥密封连接或者铁板、钢板连接。

直径：100-110mm，壁厚：3.5-5mm。长度可定做6米/根，6米之内可随意定做。

The PVC sewage pipe is necessary in the sewage system. The product has features of high strength, non-absorbent, non-leaking. It does not change and deform. The connection can be cement sealed or iron plate, steel plate.

Diameter: 100-110mm, wall thickness: 3.5-5mm. The length can be customized to within 6m.

PVC地板托梁（用于家禽养殖干湿分离的支撑）

PVC floor joist (support for dry and wet separation of poultry breeding)

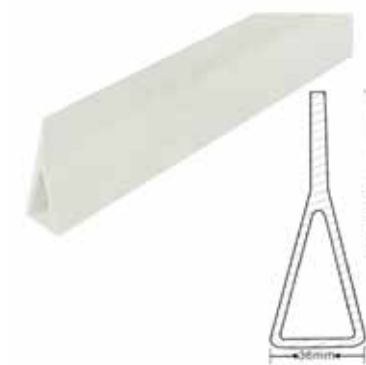

- 耐酸、耐碱、抗腐蚀  
Acid, alkali and corrosion resistance.
- 抗老化、耐候性强  
Strong aging resistance and weather resistance.
- 易清洗、无污染  
Easy to clean and non-pollution.
- 无毒无味、环保可回收  
Non-toxic, tasteless, environmental friendly and recyclable.

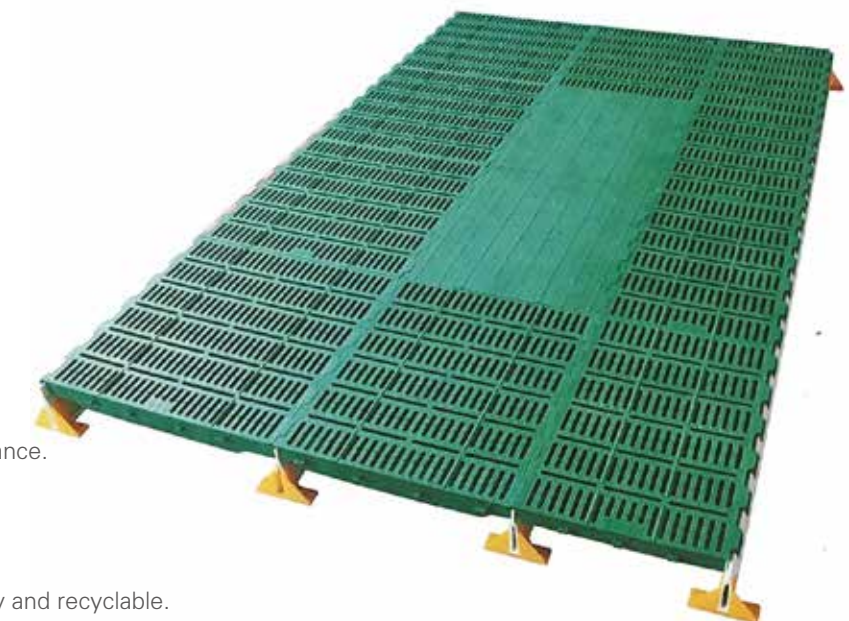



## 自动投料槽 Automatic Feeding Tank



- 下料口高、不容易堵塞、湿料适口性好，饲料阻力小，耐腐蚀。  
Feeding mouth is high and not easy to block. Feed resistance is small and corrosion resistance.
- 粉尘少，呼吸道病少，无毒无污染。  
Less dust, less respiratory diseases, non-toxic and non-pollution.
- 水位容易控制、饲料和水浪费少。  
The water level is easy to control, and there is less waste of feeding and water.
- 采用独特配方增强料管内壁耐磨度，适用绞龙及塞盘上、下料系统。  
The unique formula is adopted to enhance the abrasion resistance of the inner wall of tube which is suitable for unloading systems.

## PVC鸡饲料槽 PVC Chicken Feeding Tank



易清洁、寿命长、运输方便，定量喂食，便于家禽的集中管理，长度可定做。

PVC Chicken Feeding Profile is easy to clean, long life to maintain, and convenient to transport. By quantitative feeding, it's easy to do centralized management for the chicken. The length for the profile can be customized.

### PVC 供水方管 PVC Square Tubes

PVC 水管的优点：  
Advantages of PVC water pipe:

- 具有较好的抗拉、抗压强度。  
Good tensile and compressive strength.
- 流体阻力小：PVC管壁非常光滑，对水的阻力很小。  
Small fluid resistance: The wall thickness of PVC pipe is very smooth and the resistance to water is very small.
- 耐腐蚀性、耐药品性优良：PVC管材具有优异的耐酸、耐碱、耐腐蚀，不受潮湿水份和土壤酸碱度的影响，管道铺设时不需任何防腐处理。  
Excellent corrosion resistance and chemical resistance: PVC pipes have excellent acid resistance, alkali resistance, corrosion resistance and are not affected by moisture and soil pH. No anti-corrosive treatment is required when laying pipes.
- 具有良好的水密性：锁扣式设计，拆装简便、易清洗。  
Good water tightness: lock-type design, easy disassembly and easy to clean.



**PE/PP清粪带**  
PE/PP Manure Removal Belt



全自动清粪带，使鸡粪干燥成粒状，鸡粪的再用率高。直接可以把鸡粪送到禽舍外的清粪车上。鸡粪在禽舍内无发酵，使舍内空气清新。肉鸡群卫生防疫效果好，可以有效预防鸡传染性疾病：一旦发现疫情，可以迅速控制不使其蔓延，且鸡不接触粪便，能使肉鸡更健康的成长，给肉鸡提供了一个干净舒适的生长环境，出栏时间也很大提前，出栏率也同样得到了很大的提高。

Full automatic manure removal belt makes the chicken manure dry and become granular and improve using of it. The chicken manure can be directly sent to the truck. Chicken manure has no fermentation in the poultry house, which makes air fresh. The house for chicken has good hygienic and epidemic pervention effects, which can effectively prevent infectious diseases of chickens. Once the epidemic situation is discovered, it can be quickly controlled without spreading and the chickens do not touch the faeces, which can make chicken healthier. It will provides a clean and comfortable growth environment for them.



**主要技术参数 Main technical parameters**

种类 Species	制品厚度 Product thickness (mm)	制品宽度 Product width (mm)	适用原料 Raw material
片材 Sheet	0.8-2.0	800-1000	PP、PE

备注：以上规格参数如有变更，恕不另行通知。Note: The specifications are subject to change without prior notice.



## 海洋踏板设备 PE Marine Pedal Profile Extrusion Line

金纬机械为建设绿色海洋牧场助力！传统的近海网箱养殖以木质网箱、木质渔排和塑料泡沫为主要生产资料，在生产养殖前后都会对海域造成严重污染，而且抗风浪、抗风险能力弱，存在安全隐患。目前金纬机械提供的整套项目解决方案包括塑胶渔排踏板挤出生产线 + 海洋浮桶中空吹塑成型机 + 海洋管材生产线，是未来海洋养殖的趋势，该产品具有绿色环保，可回收，抗台风、抗老化、抗紫外线等一系列优点，保障了海洋的生态环境免遭破坏，国外已经在推广，国内沿海养殖区正在慢慢普及。主要用于海上，也可用于江、河、湖、泊、塘等。

Jwell Machinery helps to build a green marine ranch! Traditional offshore culture in net cage mainly uses wooden net cage, wooden fishing raft and plastic foam. It will cause serious pollution to the sea area before and after the production and cultivation, and it's also weak in resisting wind waves and resisting risks. At present, the whole set of project solutions provided by Jwell Machinery include Plastic Fishing Raft pedal extrusion extrusion line + marine floating bucket blow moulding machine + marine pipe extrusion line, which is the trend of marine aquaculture in the future. This product has a series of advantages, such as green environment protection, recyclability, typhoon resistance, anti-aging, anti-ultraviolet ray and so on. It ensures the marine ecological environment from being destroyed. It has been promoted abroad. Domestic coastal aquaculture areas are gradually popularizing. Mainly used in the sea, can also be used in rivers, lakes, moors, ponds, etc.



# JWZ-BM30F/160F/230F网箱浮筒中空吹塑成型机

## JWZ-BM30F/160F/230F Float Bowl Blow Molding Machine

### 性能和优点

- 适用于生产各种规格小型浮球和大型养殖浮筒
- 采用高产量挤出系统，储料式模头
- 采用伺服节能系统

### PERFORMANCE AND ADVANTAGES

- Suitable for producing different size drums and float bowls.
- Adopt high output extrusion system, accumulating die head.
- Optional hydraulic servo control system.



### 主要技术参数 Main technical parameters

名称	Model	Unit	BM30F	BM160F	BM230F
机头结构	Die head structure			储料式 Accumulating type	
主螺杆直径	Main screw diameter	mm	80/25	120/30	120/32
最大塑化能力	Max plasticizing capacity (PE)	kg/h	110	280	350
绞料电机功率	Driving motor	Kw	37	90	132
储料缸容量	Accumulating volume	L	5.2	28	32
油泵电机功率	Oil pump motor power	Kw	22	30	37
锁模力	Clamping force	KN	280	800	900
模板开距	Space between platen	mm	350-800	500-1400	800-1800
模板尺寸	Platen size W*H	mm	740*740	1120*1200	1320*1600
最大模具尺寸	Max.mould size	mm	550*800	900*1450	1200*1800
机头加热功率	Heating power of die head	Kw	15	30	36
机器外形尺寸	Machine dimension L*W*H	m	4.3*2.2*3.5	7.6*4.4*5.5	8.6*4.6*6
机器总重量	Machine weight	T	12	20	36
装机总功率	Total power	Kw	95	172	230

备注：以上规格参数如有变更，恕不另行通知。Note:The specifications are subject to change without prior notice.



## 单螺杆造粒挤出生产线 Single Screw Pelletizing Extrusion Line

采用特殊的螺杆设计及不同配置，适用于生产PP、PE、PET、PS、ABS、PA、PVC、PC、POM、EVA、PMMA等多种塑料的再生及混色造粒。减速箱采用高扭矩的设计，实现了低噪音及运转平稳等性能。螺杆、机筒经过特殊的表面处理，具有耐磨，混炼效果好，产量高的特性。真空排气或自然排气口的设计，能在生产过程中将水分、废气排除，使出料更稳定，胶粒更密实，保证了产品的优良品质。

This pelletizing extruder has the special screw design and different configuration, it is suitable for the recycling and pelletizing of raw materials such as PP, PE, PET, PS, ABS, PA, PVC, PC, POM, EVA, PMMA and the pelletizing of the raw materials with different colors. The gearbox is high torque designed which attains the functions of low noise and stable operation. The surface of the screw and barrel has been special treated so that the screw and barrel are wearable, they can have a very good plastification and mixing effect and the production capacity is high. The extruder has the vacuum vented design which can exhaust the vapor or gas during the production, so that the output can be more stable and the pellets are more dense.

### 主要技术参数 Main technical parameters

型号 Model	螺杆直径 Screw dia.(mm)	长径比 L/D	螺杆转速 Screw speed Max.(rpm)	主电机功率 Power of main motor(Kw)	生产能力 Output(Kg/h)
JWL45	45	25-36	20-120	5.5-11	18-40
JWL65	65	25-36	20-120	15-37	40-90
JWL90	90	25-36	20-95	37-75	100-250
JWL120	120	25-36	20-80	55-110	250-380
JWL150	150	25-36	20-80	110-160	300-450
JWL180	180	25-36	20-70	180-250	400-650

备注：以上规格参数如有变更，恕不另行通知。Note:The specifications are subject to change without prior notice.



## 异向锥双螺杆造粒挤出生产线 Counter Rotation Conical Twin-screw Pelletizing Extrusion Line

该机组是由系列锥形双螺杆挤出机与相应造粒辅机组成的成套设备，主要适用与PVC、PE类粉料添加木粉或填充料的造粒。生产的塑料颗粒均匀、密实、美观，辅机采用模面切粒，风送集料，振动分离冷却，具有自动化程度高，生产效率佳等特点。

This pelletizing machine is composed by a conical twin-screw extruder and the correspondingly pelletizing downstream equipment, it is suitable for the pelletizing of PVC, PE raw materials with wood powder or other additives. The pellets produced by this machine is evenly, solid, elegance. The pelletizing downstream equipment is the die face cutter, air transferring unit, vibration separating and cooling unit. This pelletizing downstream equipment has the features of high automation and high production efficiency.

### 主要技术参数 Main technical parameters

主机型号 Model	螺杆规格 (mm)	颗粒规格 (mm)	主电机功率 Power of main motor(Kw)	生产能力 Output(Kg/h)
SJZ55	55/110	ø3-ø4	22	100-120
SJZ65	65/132	ø3-ø4	37	220-260
SJZ80	80/156	ø3-ø4	55	320-450
SJZ92	92/188	ø3-ø4	110	650-800

备注：以上规格参数如有变更，恕不另行通知。Note:The specifications are subject to change without prior notice.



## 高速型材专用锥双挤出机 Conical Twin-screw Extruder for High-speed Profiles

SJZ72/152高速型材挤出机是根据市场和客户需求，我司成功开发的一款可替代普通锥双SJZ65/132和SJZ80/156挤出机的高性能挤出机，主要用于生产塑钢门窗型材等，主要配套用于高速挤出或一模双出生产线、窗台板挤出生产线等，产量高、挤出稳定、能耗低，深受用户欢迎。

SJZ72/152 conical twin-screw extruder for high speed profiles is successfully developed by our company according to the market and clients' demands, which can replace the ordinary conical extruders type SJZ65/132 and SJZ80/156. Mainly used to produce PVC door & window profiles etc, mainly for supporting high-speed extrusion line, a mode double out production line or windowsill board extrusion line and so on. Such kind of extruder is welcomed by the users with high output, extrusion stability, low-energy consumption.

### 主要技术参数 Main technical parameters

挤出机型号 Extruder type	SJZ72/152
主机马达 Motor power(kw)	45
最大挤出量 Output(kg/h)	220-270
螺杆转速 Screw speed(rpm)	5-28
配双螺杆喂料机 With twin screw feeder	1.5KW

备注：以上规格参数如有变更，恕不另行通知。Note:The specifications are subject to change without prior notice.



## 异向锥形或平行双螺杆挤出机 Conical or Parallel Twin-screw Extruder

本公司生产的SJZ和SJP各系列异向锥形或平行双螺杆挤出机，主要用来生产加工PVC管材和型材产品，具有产量高，塑化好，节能降耗，运行平稳等显著特点，电气控制配置先进，可以按照客户的要求选择电脑柜或仪表柜等。

All kinds of SJZ and SJP extruders that our company designs especially for producing the PVC pipe and profile, our extruders can promise a good plasticization, high capacity and advanced electric control, and the electrical cabinet can be chosen by customer according to their own demands.

### 主要技术参数 Main technical parameters

型号 Model	SJZ45/100	SJZ51/105	SJZ55/110	SJZ65/132	SJZ80/156	SJZ92/188
螺杆转速 rpm	34.7	34.7	34.7	34.7	34.7	34.7
电机功率 KW	15	18.5	22	37/30	55	110
生产能力 kg/h	80/110	100/120	130/150	200/250	360/400	600/800
中心高 mm	1050	1050	1050	1050	1050	1100
净重 kg	2500	3000	3500	4000	5500	8000

### 主要技术参数 Main technical parameters

型号 Model	SJP75/28	SJP93/28/31	SJP110/31	SJP120/31/26	SJP135/26
螺杆转速 rpm	45/36	45/36	45	45/34.3	34.3
电机功率 KW	45/37	75/55	110	132/110	160
生产能力 kg/h	350/220	460/380	680	850/550	1100
中心高 mm	1050	1050	1050	1050	1050
净重 kg	4100	4700	6500	7500	8400

备注：以上规格参数如有变更，恕不另行通知。Note:The specifications are subject to change without prior notice.





## 各类共挤机 All Kinds of Co-extrusion Machine

为了满足各类客户的实际需要，本公司可以提供各种用途的共挤机，用于型材前、后共挤，或者木塑制品表面包覆，也可以根据客户特殊要求，特殊设计订制。

In order to meet the actual needs of various customers, the company can provide all kinds of uses co-extrusion machine, used for profile before and after co-extrusion, or wood plastic products surface coating, can also according to customer's special requirements, special design custom-made.



### 主要技术参数 Main technical parameters

型号 Model	螺杆直径 Dia (mm)	长径比 L/D	螺杆转速 Speed (rpm)	驱动功率 Power (KW)	机筒加热功率 Power (KW)	最大挤出量 Capacity (Kg/h)	中心高 Center for high (mm)
JWS30/25	30	25	1-60	3-4	3	8-10	800-1200 可调
JWS35/25	35	25	1-50	4-5.5	6.9	10-12	800-1200 可调
JWS45/25	45	25	1-58	5.5-7.5	9	20-25	1100 ± 100
JWS50/25	50	25/28	1-58	11-15	10	25-35	1100 ± 100
JWS65/25	65	25/28	1-80	15-22	12	35-40	1100 ± 100
SJZ35/75	35/75	22.97	1-39	11	9	35-40	可调

备注：以上规格参数如有变更，恕不另行通知。Note:The specifications are subject to change without prior notice.



## 单螺杆挤出机 Single Screw Extruder

该机型主要用于异型材产品的挤出，螺杆机筒的结构形式多样，加工精度高，塑化好，产量高，适合不同用户需求，电气控制元件配置高档，可靠性好。适合加工PVC/PC/ABS等各种异型材产品。

This model of equipment mainly used to extrude profile, the structure and form of screws and barrels vary a lot, and the screws and barrels are processed precisely which can guarantee a good plasticization, high capacity and can meet different customer's needs, the electrical controlling parts are equipped in high class which made it safe to operate. Suitable for PVC/PC/ABS Profile.

### 主要技术参数 Main technical parameters

型号 Model	螺杆直径 Dia(mm)	长径比 L/D	传动功率 Power(KW)	螺杆转速 Speed(rpm)	最大产量 Capacity(Kg/h)	加工树脂 Processing resin	中心高 Center for high(mm)
JWS45	45	25/28	11/15/18.5	10-100	25/30/38	PVC/ABS/PC等	1000
JWS65	65	25/28	18.5/22/30	10-100	50/60/80	PVC/ABS/PC等	1000
JWS75	75	25/28	37	10-100	80	PVC/ABS/PC等	1000
JWS80	80	28/30	37	10-90	100	PP/ABS/PC等	1000
JWS90	90	28/30	45	10-90	120	PP/ABS/PC等	1000
JWS120	120	28/30	75	10-90	250	PC/ABS等	1000

备注：以上规格参数如有变更，恕不另行通知。Note:The specifications are subject to change without prior notice.



## 化纤挤出机 Spining Extruder

JWM系列螺杆挤出机主要用于PET、PA6、PA66、PP等切片的熔融纺丝。挤出机的螺杆设计采用LTM低温混合元件，塑化性能好。由于采用了专业加工技术，使得螺杆、料筒的制造精度较高，直线性较好。并选用高精度斜齿减速箱，齿轮为硬齿面磨齿齿轮。工作平稳，噪声极小。配用超强的推力轴承，保证能承受巨大的轴向力。并可根据用户需要，选用进口轴承及密封件，耐用性好，维护简便。

JWM series extruders are used for melt spining of PET, PA6, PA66, PP chips. The LTM designed in screw, and the melt quality is better. The precision of screw and barrel is higher after professional processing. And equipped high precision bevel-teeth gear box, operating stability, lowest noise. assemble strong push bearing. in ord to guarantee bearing huge axle power. and be able to select to equip imported high speed bearing and seal parts.

### 主要技术参数 Main technical parameters

JWM 挤出机规格	螺杆 直径	长径比 L/D	最大 挤出量	螺杆 转速	机头 压力	传动 功率	加热 功率	加热 区段	加热 电压	中心高	重量
Extruder spec	Screw dia	L/D	Max. output	Screw rpm	Pressure	Transmission power	Heating power	Heating section	Heating voltage	Center height	Weight
	mm		kg/h	r/min	Mpa	kw	kw		v	mm	ton
JWM45/25	ø45	25: 1	38	20-90	15-25	7.5	8	3	220	340	1
JWM65/25	ø65	25: 1	78	20-90	15-25	18.5	16	5	220	340	1.3
JWM80/25	ø80	25: 1	115	20-80	15-25	37	27	5	220	510	1.8
JWM90/25	ø90	25: 1	196	20-80	15-25	45	32	5	220	510	2
JWM105/25	ø105	25: 1	295	20-70	15-25	55	45	5	220	610	3
JWM120/25	ø120	25: 1	390	20-60	15-25	75	54	6	220	660	3.5
JWM135/25	ø135	25: 1	535	20-60	15-25	90	63	6	220	660	4.2
JWM150/25	ø150	25: 1	652	20-60	15-25	110	76.5	6	380	710	5
JWM160/25	ø160	25: 1	705	20-60	15-25	132	85.5	6	380	710	6
JWM170/25	ø170	25: 1	850	20-60	15-25	160	103.5	6	380	720	8
JWM180/25	ø180	25: 1	972	20-50	15-25	185	110	7	380	800	10
JWM200/25	ø200	25: 1	1050	20-50	15-25	200	150	7	380	1000	12

以上规格参数如有变更，恕不另行通知。(PP或100%PET瓶片:L/D=30:1 or 28:1)



## PP无纺布挤出机 PP Non-woven Fabrics Extruder

JWM系列PP无纺布螺杆挤出机主要用于纺粘法PP无纺布料的挤出生产。该挤出机一般为两台挤出机串联挤出，主挤出机螺杆长径比为30:1，副挤出机主要加工在线回收的边角料和废布料，螺杆长径比一般用15:1；客户可以根据需要选配合适自己的机型组合，用以生产不同宽幅的无纺布产品。

JWM series Non-woven fabrics Extruder are specialized in PP Non-woven fabrics production. Normally it uses two extruders in series. the screw L/D of the main extruder is 30:1, the ancillary extruder mainly used for machining leftover material and flot-sam drapery which can be recycled on the line, the L/D is mainly 15:1. various kinds of the extruder model for different width Non-woven fabrics products.

### 主要技术参数 Main technical parameters

螺杆直径 mm	规格型号 L/D	螺杆转速 rpm	传动功率 Kw	加热功率 Kw	加热区段	加热电压 V	中心高 mm	重量 t	备注
ø135	135/30	20-60	75	80	6	220	660	4.5	适合做1.6米
ø105	105/15	20-80	15/18.5	18	4			2	宽幅的无纺布
ø150	150/30	20-60	110	90	7	380	710	5.5	适合做2.4米
ø105	105/15	20-80	15/18.5	18	4	220		2	宽幅的无纺布
ø160	160/30	20-60	132	100	7	380	710	6.5	适合做2.4米
ø105	105/15	20-80	22	18	4	220		2	宽幅的无纺布
ø170	170/30	20-60	132	110	7	380	710	8.5	适合做3.2米
ø105	105/15	20-80	22	18	4	220		2	宽幅的无纺布
ø180	180/30	20-50	160	120	7	380	720	10.5	适合做3.2米
ø120	120/15	20-80	30	24	4	220		2.5	宽幅的无纺布

备注：以上规格参数如有变更，恕不另行通知。Note:The specifications are subject to change without prior notice.





## 工艺流程 Flow Chat of WPC Production

### Outdoor Products ( PE、PP、PS ) Flow Chat of WPC Two-step Line

门板室外产品 ( PE、PP、PS ) 木塑两步法流程图

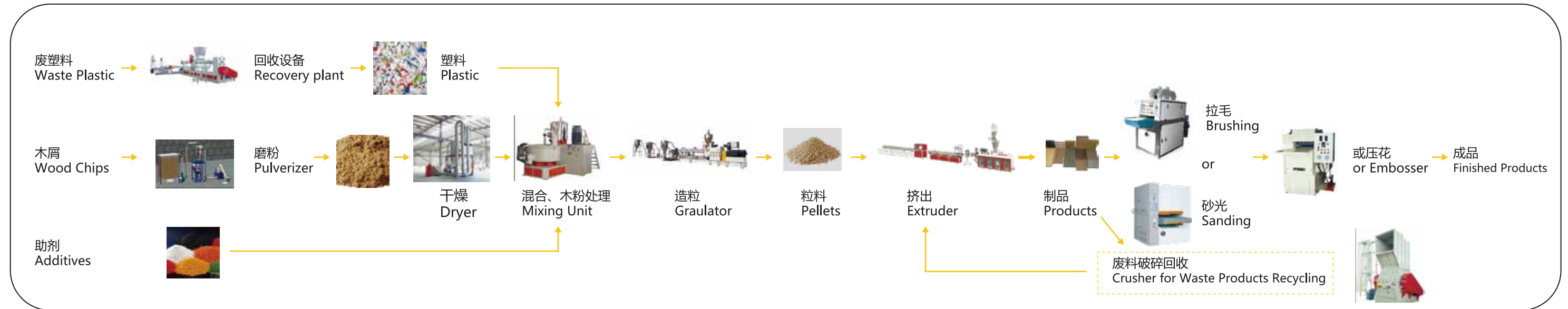

### Indoor Products Flow Chat of WPC process

室内产品 ( PVC 发泡 ) 木塑工艺流程图

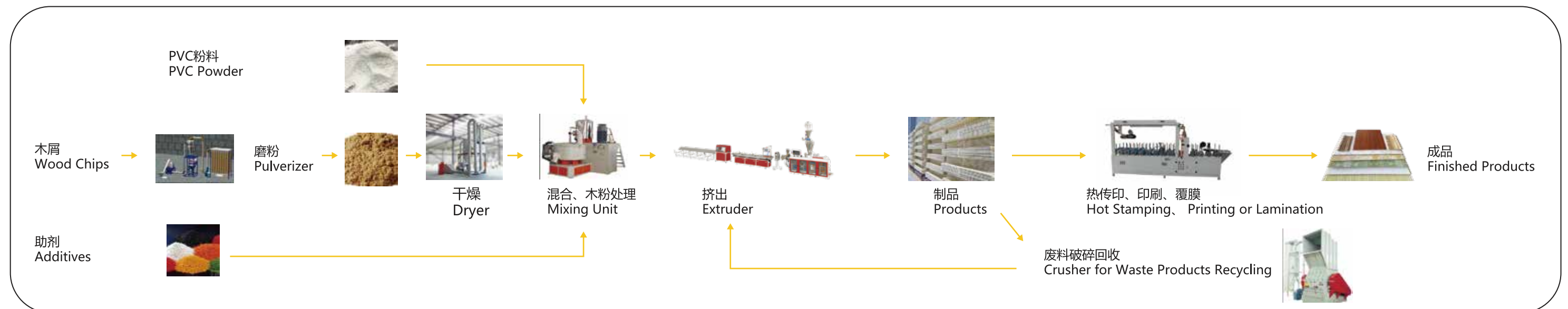

**相关公司产品链接 Linkage of Relating Auxiliary Equipment**



螺杆、机筒  
Screw and barrel



自动换网器和液压站  
Hydraulic screen changer



同向双螺杆造粒机组  
Co-rotation parallel twin-screw pelletizing machine



涂布单元  
Coating machine



挤出机  
Extruder



各类镜面辊筒  
All kinds of mirror rollers



模具和分配器  
T-die and feedblock



800/2500 的卧式混料机  
Mixer



破碎机  
Crusher



## 挤出机械物联网+智能制造解决方案

工业4.0时代的互联-CPS（信息物理系统cyber physical systems），不是简单的对互联网、物联网、传感网的替代，它是信息世界和物理世界的深度融合。

未来挤出装备不再是一个孤立的自动化、信息化孤岛，未来的挤出机工厂会通过云平台与整个供需体系形成灵活智能的产品制造网络。工业4.0背景下的智能挤出发展趋势，多品种小批量快周期的定制化生产；多种生产技术和工艺的高度集成化；少人或无人状态下的自主生产过程；从原料到成品整个过程的信息化管理……

The interconnected in the industrial 4.0--CPS (cyber physical systems) is not a simple alternative to the Internet, the Internet of things, and the sensing network. It is a deep integration of the information and the physical.

The future extrusion equipment is no longer an isolated automation and information island. The future extruder factory will form a flexible and intelligent product manufacturing network through the cloud platform and the whole supply and demand system. In the industrial 4.0 background, the development trend of intelligent extrusion, customized production of multi variety and small batch fast cycle; High integration of various production techniques and processes; autonomous production process under less people or unmanned state; information management from the whole process of raw material to finished product...

在朝着工业4.0发展的过程中，我们的设备更智能化了！金纬机械智能化生产线：

- 1.可以监测主机电流
- 2.可以监测主机温度
- 3.可以监测主机电能
- 4.可以监测主机每吨物料能耗（目前仅支持有米重控制的设备）
- 5.可以在手机上查看数据信息
- 6.可以记录并统计设备故障，部件更换等信息
- 7.可以连接MES系统
- 8.可以远程调试程序

In the process of industrial 4.0, our equipment is more intelligent! Intelligent production line of Jwell:

1. Can monitor the current of the extruder.
2. Can monitor the temperature of the extruder.
3. Can monitor the power of the extruder.
4. The energy consumption per ton of material can be monitored. (At present, only equipment with rice weight control is supported)
5. You can view the data on the phone.
6. Records and statistics of equipment failure, parts replacement and other information can be recorded and counted.
7. Can connect the MES system.
8. The program can be debugged remotely.



实时工况  
Real-time operating status



作业情况统计  
Working status statistics

## Plastic Machinery Fully Integrated Automation + Internet Of Things Control System Solutions

基于MES系统平台，实现车间生产管理的信息沟通平台，并向智能化方向发展。

Based on the MES system platform, the information communication platform of workshop production management is realized and move toward the intelligent direction





**企业风采：品质管理 技术研发 国际交流 客户服务 员工培训**

**Quality Control Technology Research International Communication Customer Service Staff Training**



24小时服务  
24 Hours Service

86-573-87786088  
客户服务热线  
Customer Service Hotline

培训  
Training

交钥匙工程  
Turn-Key Project